

This manual contains **IMPORTANT WARNINGS** and **INSTRUCTIONS**.  
 Equipment in this manual is exclusively for painting purposes.  
 Do not use for other purposes.  
 The operator shall fully understand the requirements stated in this instruction manual  
 including important warnings, cautions, operation and correct handling.  
 Read and understand the instruction manual before use and retain for reference.

## Instruction Manual

### Reusable / Disposable paint cup system for spray gun

# MIX and SPRAY SYSTEM



ANEST IWATA: LPH400 / W400 / LPH300 / W300 Series

AIR GUNSA : AZ3 Series

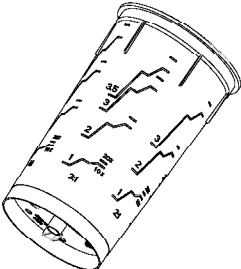
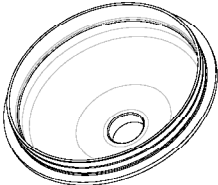
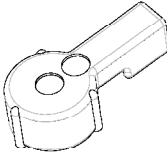
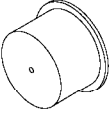
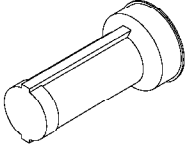
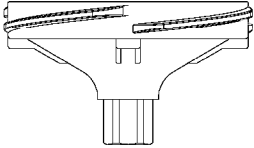
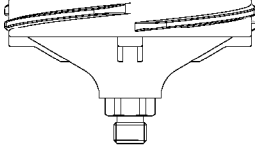
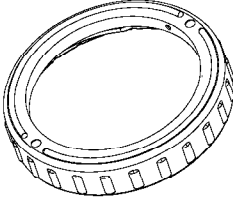
## ■ COMPONENTS

DISPOSABLE PARTS				
<p>CUP 600 [ml]</p> 	<p>INNER LID</p> 	<p>KNOB</p> 	<p>PLUG</p> 	<p>PAINT FILTER</p> 
REUSABLE PARTS				
<p>CUP HOLDER (Female Fitting)</p> <p>For LPH400 and W400</p> 	<p>CUP HOLDER (Male Fitting)</p> <p>For LPH300, W300 and AZ3</p> 	<p>RING</p> 		

## ■ SAFETY WARNING

<p><b>⚠ FIRE OR EXPLOSION HAZARD</b></p> <ol style="list-style-type: none"><li>Fluid and/or solvents can be highly flammable or combustible.<ul style="list-style-type: none"><li>Use in well-ventilated spray booth.</li><li>Avoid any ignition sources such as smoking, open flames, electrical hazard, etc.</li></ul></li><li>To reduce the risk of static sparking, grounding continuity to the spray equipment and object being sprayed must be maintained.</li></ol>	
<p><b>⚠ MISUSE HAZARD</b></p> <ol style="list-style-type: none"><li>Always release air and fluid pressures before cleaning, disassembling or servicing. For emergency stop and prevention of unintended operation, a shut off valve installed near the spray gun to stop air supply is recommended.</li></ol>	
<p><b>⚠ HAZARD CREATED WHILE COATING MATERIALS ARE ATOMIZED AND SPRAYED</b></p> <ol style="list-style-type: none"><li>Toxic vapors produced by spraying certain materials can create intoxication and serious damage to health.<ul style="list-style-type: none"><li>Use in well-ventilated areas</li><li>Always wear protective eyewear, gloves, respirator, etc., to prevent toxic vapor hazard, solvents and paint from coming into contact with your eyes or skin.</li></ul></li></ol>	
<p><b>⚠ OTHER HAZARDS</b></p> <ol style="list-style-type: none"><li>Never modify this product for any applications.</li><li>Never spray food or chemicals through spray guns.</li><li>If operation appears incorrect, immediately stop operation and find the cause.</li><li>Never use until problem has been solved.</li><li>Pay attention to avoid hitting or dropping this product, especially threaded and seated parts.</li></ol>	
<p><b>⚠ IMPORTANT</b></p> <ol style="list-style-type: none"><li>This product should be operated by adequately trained operators only.</li><li>Check to ensure that this product has not been damaged during transportation.</li></ol>	

## ■ INSTALLATION

- Install **CUP HOLDER** to the **FLUID JOINT** of the spray gun and tighten firmly by using **WRENCH** (Fig.1).
- Hand tighten **RING** to the **CUP HOLDER** to avoid damage when **CUP SYSTEM** is not in use (Fig.2).

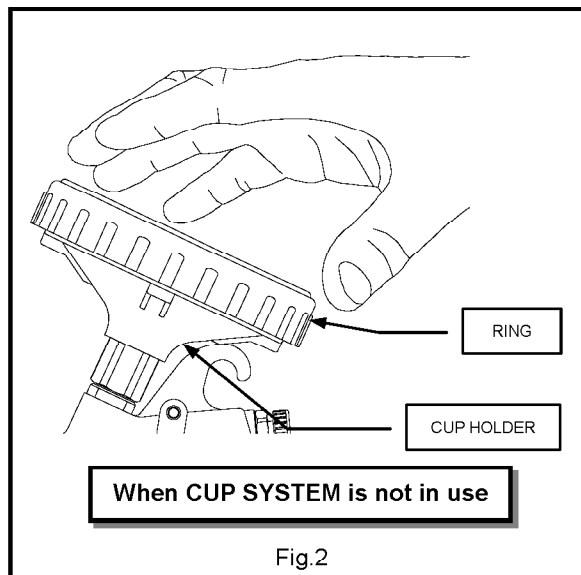
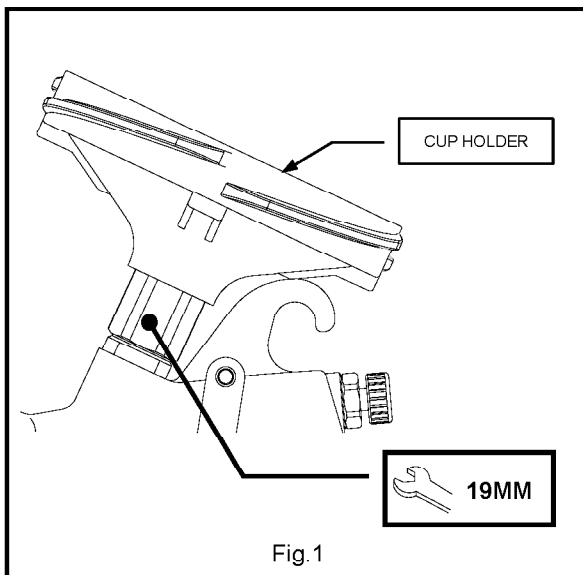

# PAINT MIXING

1. Press **KNOB** firmly to bottom of **CUP** (Fig.3), and set it in the "MIX-CLOSE POSITION" (Fig.4).
2. Mix paint (Fig.5).

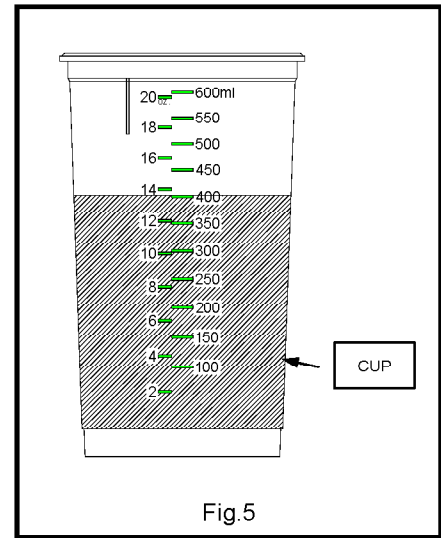
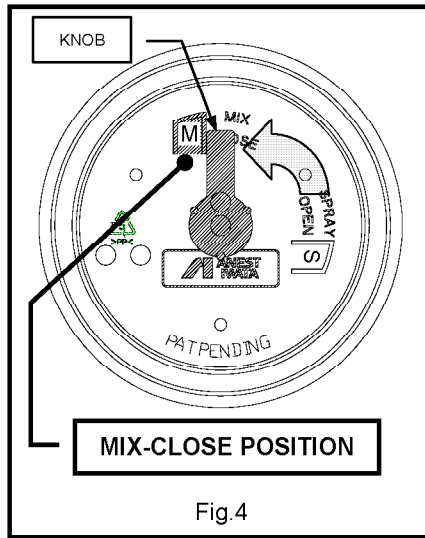
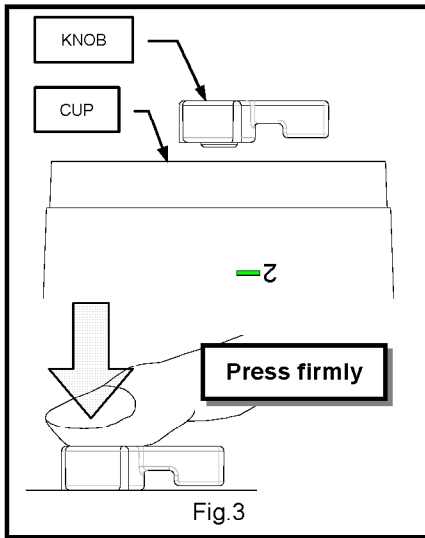

Reference indications for preparing paint with volume ratio, not with weight ratio

Standard indication by volume

Paint mix indications by ratio

How to read paint mix indications by ratio  
Example: Mixing ratio 2:1 (Paint : Hardner)

2

20%

10%

④ 20% solvent level

③ 10% solvent level

② Hardener level

① Paint level

2:1

Follow paint manufacture's recommendations

## ■ HOW TO SPRAY

1. After mixing paint, place the **CUP** inside the **RING** (Fig.6).
2. Insert **PAINT FILTER** on the **INNER LID** if necessary (Fig.7).
3. Affix the **INNER LID** to the **CUP** (Fig.8).
4. Hold the spray gun with the **CUP HOLDER** upside down, and place on top of the **CUP ASSEMBLY** (Fig.9).  
Make sure that the outside of the **INNER LID** and the inside of the **CUP HOLDER** are thoroughly cleaned and free of dirt or paint residue.
5. Slide the **RING** to the **CUP HOLDER** and hand tighten the **RING** firmly (Fig.10).
6. Trigger once, to remove excess pressure brought by vaporizing while the spray gun is upside down (Fig.11).
7. Turn the spray gun to upright position and check the **RING** and the **CUP ASSEMBLY** for secure fit (Fig.12).
8. Make sure the **RING** is properly tightened before and during operation.
9. Set the **KNOB** to "**SPRAY-OPEN POSITION**" (Fig.13), and begin to spray (Fig.14).  
Do not turn spray gun upside down when the **KNOB** is in the "**SPRAY-OPEN POSITION**".

 <b>CAUTION</b>	<p>Paint may spout from under <b>KNOB</b></p> <ul style="list-style-type: none"> <li>- especially when highly volatile materials are used at higher temperatures.</li> <li>- if spray gun and <b>MIX and SPRAY SYSTEM</b> are shaken vigorously while spraying.</li> <li>- if spray gun and <b>MIX and SPRAY SYSTEM</b> are operated at extreme angles.</li> </ul>
--	--

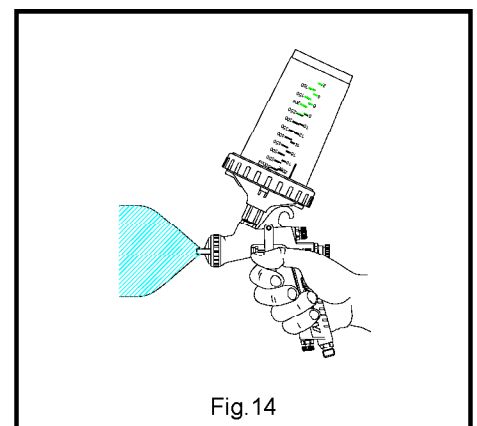
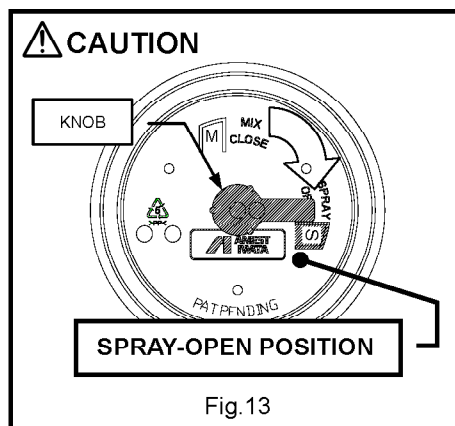
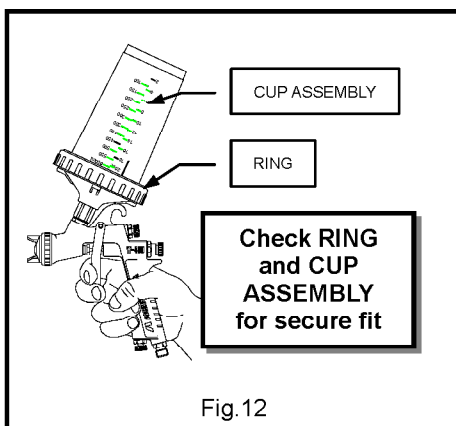
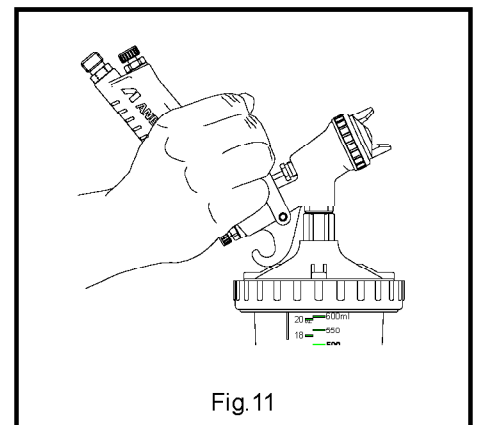
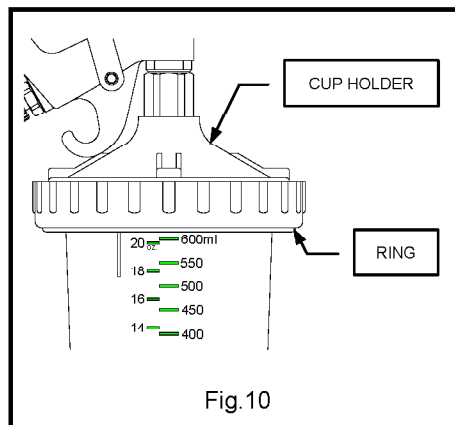
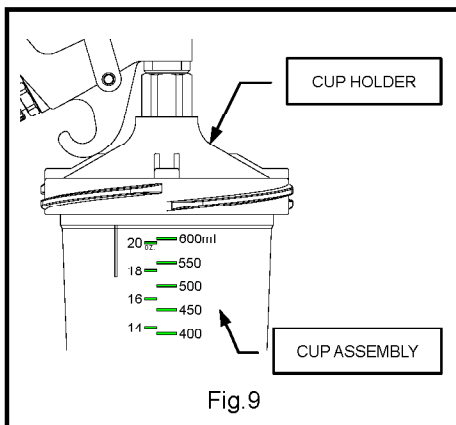
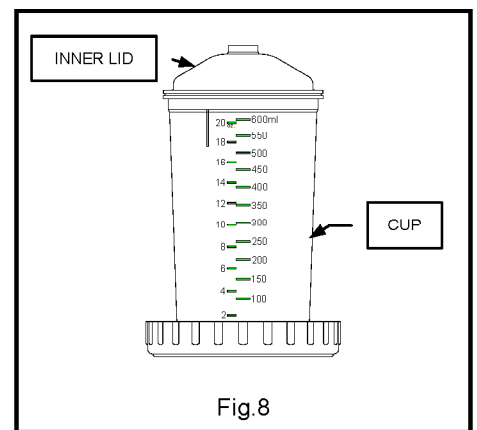
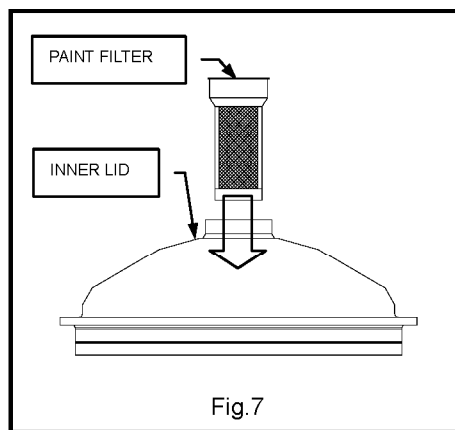
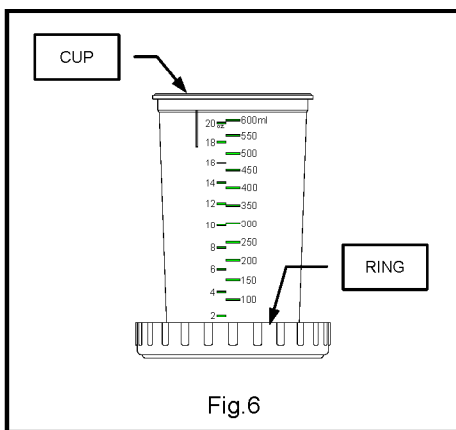

## ■ AFTER SPRAYING

1. **AFTER** spraying, firmly set the **KNOB** to the “**MIX-CLOSE POSITION**” and press firmly (Fig.15).
2. Stop compressed air supply to the spray gun and trigger while upside down to recover remaining paint from the spray gun to the **CUP** completely (Fig.16).  
Recovering paint may take longer when **FILTER** is installed.
3. Remove the **RING** from the **CUP HOLDER** (Fig.17).
4. To avoid paint spouting when removing the **CUP HOLDER** from the **CUP ASSEMBLY**, **KEEP TRIGGERING** when lifting the spray gun upwards while slightly turning to insure the **INNER LID** does not become detached from the **CUP** (Fig.18).  
Squeezing **CUP** may cause **INNER LID** to detach from **CUP** unexpectedly when **CUP HOLDER** is being removed.
5. Clean the fluid passage of the spray gun and the **CUP HOLDER** (Fig.19).

**⚠ IMPORTANT** Be sure to follow local guidelines for proper cleaning and paint disposal procedures.

6. Hand-tighten the **RING** to the **CUP HOLDER** to avoid damage when **CUP SYSTEM** is not in use (Fig.20).
7. Disassemble the **CUP HOLDER** from the spray gun with **WRENCH** and clean inside the spray gun again if necessary.

**⚠ IMPORTANT** Be sure to follow local guidelines for proper cleaning and paint disposal procedures.

8. To reuse the disposable parts, disassemble the **INNER LID** from the **CUP** (squeeze the **CUP** gently to avoid paint spouting, Fig.21).  
Remove **PAINT FILTER** if necessary and clean.

**⚠ CAUTION** Paint may spout when squeezing **CUP**.

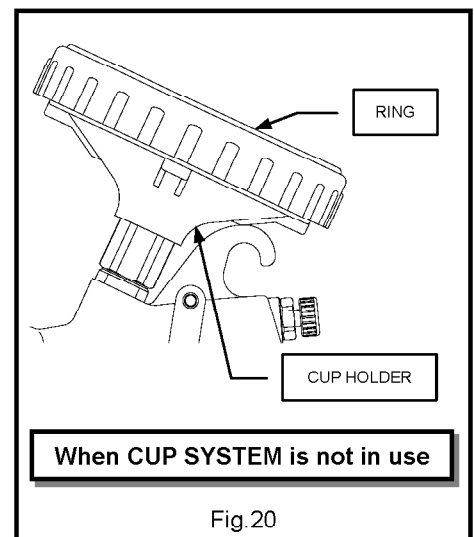
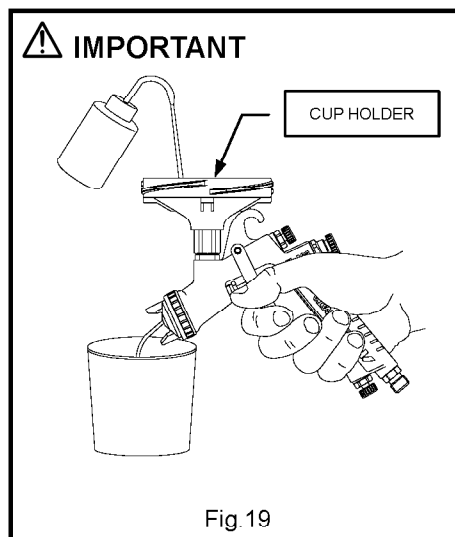
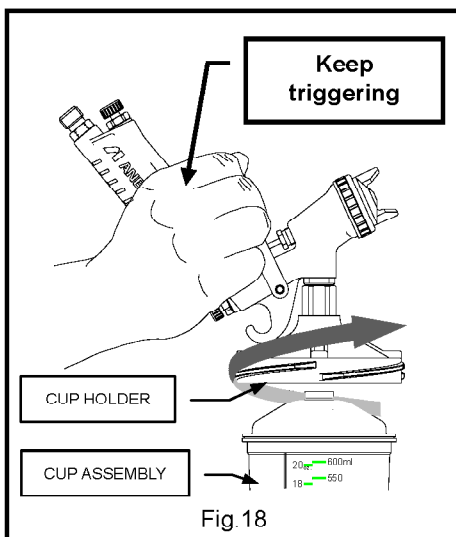
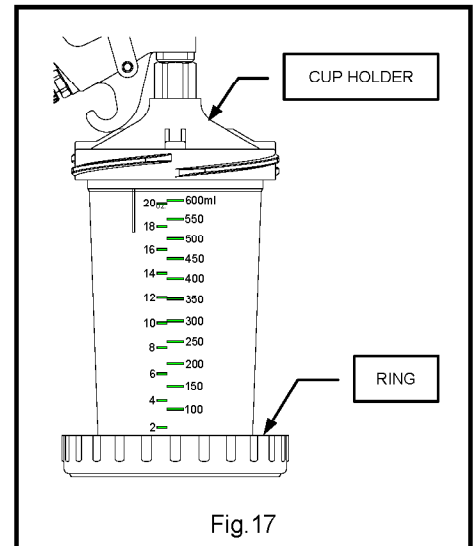
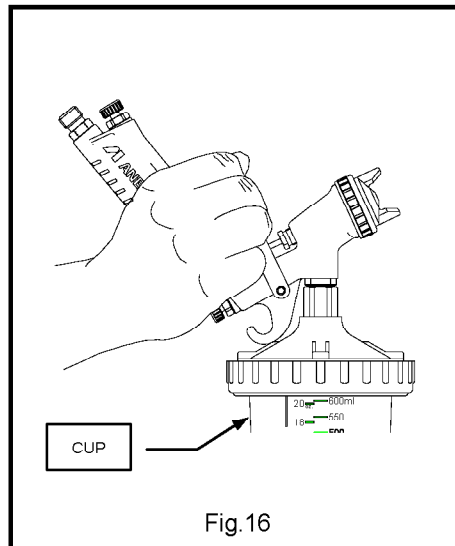
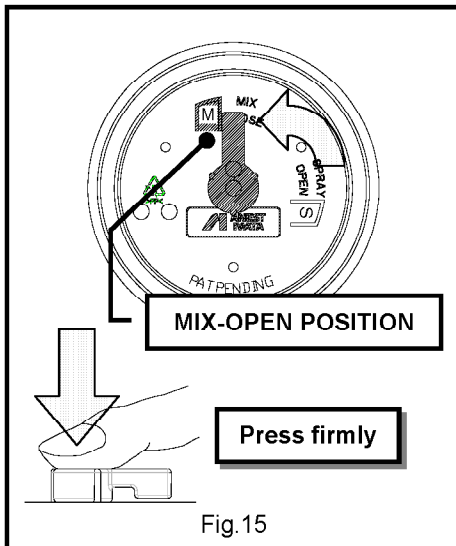

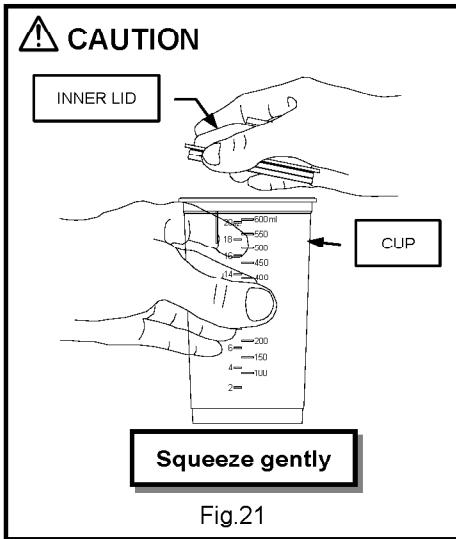

## ■ TEMPORARY PAINT STORAGE

1. For temporary paint storage, place **PLUG** on the **INNER LID** (Fig.22).  
Remove **PAINT FILTER** if installed before placing the **PLUG**.

**⚠ IMPORTANT** Be sure to follow local guidelines for proper storage procedures.

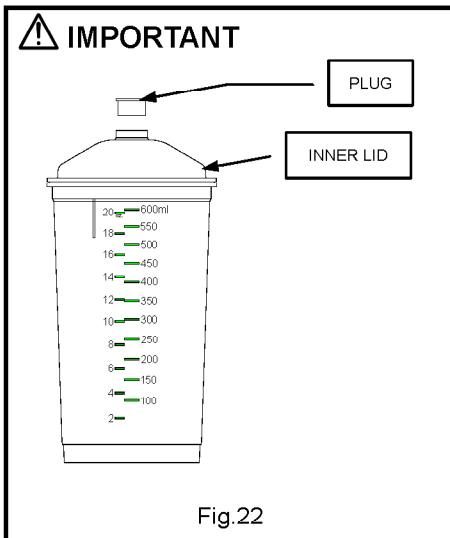

## ■ DISCARDING OF DISPOSABLE PARTS

1. Make sure that solvent and wet paint do not remain inside the **CUP** before discarding the **CUP ASSEMBLY**.  
Disposable parts are made of **POLYPROPYLENE**.

**⚠ IMPORTANT** Be sure to follow local guidelines for proper disposal procedures.

## ■ MAINTENANCE AFTER OPERATION

 <b>WARNING</b>	1. Before disassembling, cleaning or servicing, turn off compressed air supply to spray gun and release air and fluid pressure by triggering.
	2. Do not disassemble without receiving enough knowledge and training.

1. After operation, clean the **CUP HOLDER** and fluid passage of the spray gun using proper materials.

 <b>IMPORTANT</b>	Be sure to follow local guidelines for proper cleaning procedures.
--	--

2. Check that, no leakage occurs between the **CUP HOLDER** and the **FLUID JOINT** of the spray gun.  
3. Check for damage and wear on threaded and seated parts.

 <b>CAUTION</b>	1. Always use <b>ANEST IWATA</b> spare parts.
	2. Never use damaged parts.
	3. Damaged parts need to be replaced immediately.

## ■ TROUBLE SHOOTING

Remedy - R1: Retighten, R2: Adjust, R3: Clean, R4: Replace

Problem	Where it occurred	Parts to be checked	Caused	Remedy			
				R1	R2	R3	R4
Paint leakage	Between KNOB and CUP	KNOB CUP	KNOB is not at "MIX-Close POSITION"		X		
			Loose KNOB	X			
			Dirt or damage on seat			X	X
	Between CUP and RING Between CUP HOLDER and RING	CUP RING CUP HOLDER	Loose RING	X			
			Dirt or damage on seat			X	X
	Between CUP HOLDER and FLUID JOINT	CUP HOLDER FLUID JOINT	Loose CUP HOLDER	X			
Dirt or damage on seat					X	X	
Paint does not come out	Tip of FLUID NOZZLE	KNOB CUP	KNOB is not at "SPRAY-Open POSITION"		X		
			Vent hole of KNOB is blocked			X	
		PAINT FILTER	Clogged			X	X

\*Reference spray gun instruction manual



ANEST IWATA USA, Inc.  
9920 Windisch Road  
West Chester OH 45069-3804  
(513) 755-3100 FAX: (513) 755-0888  
Toll Free: (800) 440-0282  
[www.anestiwata.com](http://www.anestiwata.com)

Manual Nr. T018-00